

**de** Montageanleitung  
**en** Mounting instructions  
**fr** Instructions de montage  
**sv** Monteringsinstruktion  
**nl** Montage-aanwijzing  
**it** Istruzioni di montaggio  
**fi** Asennusohje  
**es** Instrucciones de montaje  
**da** Monteringsvejledning  
**zh** 安装指导  
**ko** 설치 지침서  
**ja** 取扱説明書

**Drehantrieb**  
**Rotary-type actuator**  
**Servo-moteur à action angulaire**  
**Spjällställdon med vridande rörelse**  
**Luchtklepservomotor voor rot. aandrijving**  
**Servocomando rotativo per serrande**  
**Kiertoliikkeinen ilmapeltien toimimoottori**  
**Actuador de acción rotativa**  
**Motor for drejebevægelse**  
**旋转型执行器**  
**로터리타입 조작기**  
**ロータリー式ダンパーアクチュエータ**

**GQD...1**

**A**

**Lieferumfang**  
**Deliverables**  
**Contenu**  
**Leverans**

**Leveringsomvang**  
**Contenuto**  
**Toimituslaajuus**  
**Contenido**

**Leverancens omfang**  
**设备构件**  
**제품의 공급 (구성품)**  
**製品及び付属品**

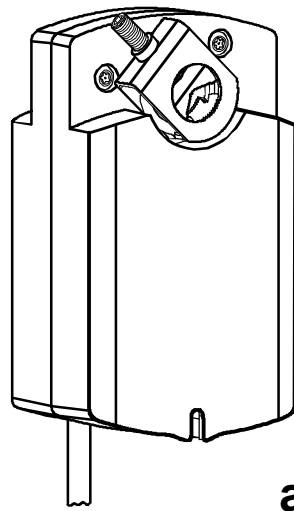

**a**

DIN7981  
 St 4,8 x 13



**c**

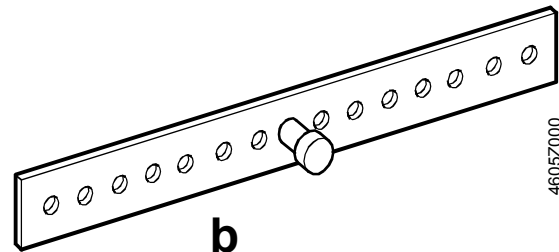

**b**

4605Z000

**B**

**Hinweise / Warnungen**  
**Notes / Warnings**  
**Indications / Mise en garde**  
**Hänvisningar / Varningar**







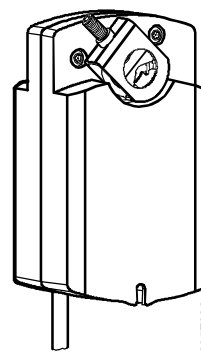





**Aanwijzingen / Waarschuwingen**  
**Messa in servizio / Indicazioni**  
**Huomauksia / Varoituksia**  
**Indicaciones / Consejos**













**Bemærkninger / Advarsler**  
**提示 / 警告**  
**주의사항**  
**保護等級 / 注意**













**IP40**  
 In all positions



4605Z002

<p><b>de</b></p> <p><b>Diese Anleitung ist beim Antrieb oder in der Anlagendokumentation aufzubewahren!</b></p> <p> Dieses Symbol weist auf Gefahren und Maßnahmen zum Schutz von Personen und Sachen hin:</p> <ul style="list-style-type: none"> <li>• Antriebe für AC 230 V dürfen nur durch autorisiertes Personal angeschlossen werden.</li> <li>• Zulässige Spannungen an den Hilfsschaltern: Siehe Tabelle unter "Geräteschaltpläne".</li> <li>• Die Anschlusskabel des Antriebs dürfen nicht im Wasser liegen.</li> </ul> <p> Gerät der Schutzklasse II (Schutzisolierung)</p> <p> Gerät der Schutzklasse III (Schutzkleinspannung)</p> <p> <b>Achtung!</b> Der Stellantrieb darf nicht geöffnet werden</p> <p><b>Verdrahtung und Inbetriebnahme</b> Siehe in den anlagenspezifischen Unterlagen und im Datenblatt N4604 zum Antrieb.</p>	<p><b>sv</b></p> <p><b>Denna instruktion skall förvaras tillsammans med ställdonet eller anläggningsdokumentationen!</b></p> <p> Denna symbol gäller riskfaktorer samt åtgärder för att undvika person- och materialskador.</p> <ul style="list-style-type: none"> <li>• Ställdon med AC 230 V får anslutas endast av behörig personal.</li> <li>• Tillåten spänning för hjälpkontakter, se tabellen i avsnitt kopplingscheman.</li> <li>• Ställdonets anslutningskabel får inte ligga i vatten.</li> </ul> <p> Apparat i isolerclass II (skyddsisolering)</p> <p> Apparat i isolerclass III (skyddsisolering)</p> <p> <b>OBS!</b> Ställdonet får inte öppnas.</p> <p><b>Elektrisk inkoppling och igångkörning</b> Se anläggnings-specifika underlag och i „datablad N4604“ för ställdonet.</p>	<p><b>fi</b></p> <p><b>Tätä ohjetta tulee säilyttää toimimoottorin läheisyydessä tai yhdessä laitosdokumenttien kanssa!</b></p> <p> Tämä symboli viittaa vaaraan ja toimenpiteisiin, joita tarvitaan henkilö- ja aineellisten vahinkojen välttämiseksi:</p> <ul style="list-style-type: none"> <li>• Ainoastaan valtuutetut ammattihenkilöt saavat liittää 230 VAC:n toimimoottoreita.</li> <li>• Sallitut jännitteet apukytkimissä: katso "Kytentäkaaviot"-kappaleessa oleva taulukko.</li> <li>• Toimimoottorin liitäntäkaapelit eivät saa kastua tai muuten altistua vedelle.</li> </ul> <p> Suojausluokan II laite (suoraerotus)</p> <p> Suojausluokan III laite (suojaerotus)</p> <p> <b>Huomio!</b> Toimimoottoria ei saa avata.</p> <p><b>Johdotus ja käyttöönotto</b> Katso laitoskohtaiset dokumentit ja tekninen esite N4604.</p>
--	---	---

<p><b>en</b></p> <p><b>Store these instructions together with the actuator or with the plant documentation!</b></p> <p> This symbol denotes dangers and measures to avoid personal injury and property damage:</p> <ul style="list-style-type: none"> <li>• Only authorized personnel may connect actuators for AC 230 V.</li> <li>• Refer to the table in "Diagrams" for the voltages permissible at the auxiliary switches.</li> <li>• Do not expose the actuator's connecting cables to water or lay the cables in water.</li> </ul> <p> Device of protection class II (protective insulation)</p> <p> Device of protection class III (protective insulation)</p> <p> <b>Warning!</b> Do not open the actuator.</p> <p><b>Wiring and commissioning</b> Refer to the actuator's commissioning instructions and datasheet N4604.</p>	<p><b>nl</b></p> <p><b>Deze handleiding moet bij de servomotor, of met de documentatie van de installatie worden bewaard!</b></p> <p> Dit symbool wijst op gevaar en maatregelen ter bescherming van personen en materiaal:</p> <ul style="list-style-type: none"> <li>• AC 230 V aandrijvingen mogen alleen door bevoegd personeel worden aangesloten.</li> <li>• Voor toelaatbare spanningen aan hulpschakelaars: Zie tabel onder "Aansluitschema's".</li> <li>• De aansluitkabel van de aandrijving mag niet in het water liggen.</li> </ul> <p> Apparaat van beschermingsklasse II (beschermings isolatie)</p> <p> Apparaat van beschermingsklasse III (beschermings isolatie)</p> <p> <b>Opgelet!</b> De servomotor mag niet worden geopend.</p> <p><b>Bekabeling en inbedrijfstelling</b> Raadpleeg de installatie-documentatie en "Apparatenblad" N4604 van de servomotor.</p>	<p><b>es</b></p> <p><b>Conserve estas instrucciones con el actuador o con la documentación de la instalación!</b></p> <p> Este símbolo denota peligro y medidas para evitar daños personales y de la propiedad:</p> <ul style="list-style-type: none"> <li>• Sólo el personal autorizado puede conectar los actuadores a 230 V CA.</li> <li>• Consultar la tabla de "Conexión eléctrico" para saber la tensión permitida en los contactos auxiliares.</li> <li>• No exponer los cables de conexión del actuador al agua ni dejarlos en contacto con ésta.</li> </ul> <p> Equipo con tipo de protección II (aislamiento protegido)</p> <p> Equipo con tipo de protección III (aislamiento protegido)</p> <p> <b>Atención!</b> el actuador no debe ser abierto.</p> <p><b>Cableado y puesta en marcha</b> Referirse a las instrucciones de puesta en marcha del actuador y de la hoja técnica N4604.</p>
---	---	--

<p><b>fr</b></p> <p><b>Cette instruction est à conserver avec le servomoteur ou avec la documentation de l'installation!</b></p> <p> Ce symbole signale un danger pour les personnes et les biens et les mesures y-afférentes :</p> <ul style="list-style-type: none"> <li>• Le branchement des servomoteurs 230 V~ ne doit être effectué que par un personnel qualifié.</li> <li>• Tensions admissibles sur les contacts auxiliaires : cf. "Schémas de raccordement".</li> <li>• Les câbles de raccordement du servomoteur ne doivent pas être en contact avec l'eau.</li> </ul> <p> Classe d'isolation II (isolation de protection)</p> <p> Classe d'isolation III (isolation de protection)</p> <p> <b>Attention!</b> Le servo-moteur ne doit pas être ouvert.</p> <p><b>Câblage et mise en service</b> Se référer à la documentation de l'installation et à la fiche produit N4604 du servomoteur.</p>	<p><b>it</b></p> <p><b>Queste istruzioni devono essere conservate con la documentazione dell'impianto!</b></p> <p> Questo simbolo indica – pericolo – il personale deve fare attenzione per evitare ferite o danni.</p> <ul style="list-style-type: none"> <li>• I collegamenti a 230 V CA . devono sempre essere eseguiti da personale autorizzati.</li> <li>• Fare riferimento alle " tabelle tecniche" per la tensione ammessa per i contatti ausiliari.</li> <li>• Non esporre all'acqua il cavo ed i collegamenti elettrici.</li> </ul> <p> Apparecchi di protezione classe ii (protezione isolamento)</p> <p> Apparecchio di protezione classe III (protezione isolamento)</p> <p> <b>Attenzione!</b> Il servocomando non deve essere aperto.</p> <p><b>Menti e messa in servizio</b> Consultare la documentazione per l'installazione e il folio tecnico (N4604) del servocomando.</p>	<p><b>da</b></p> <p><b>Opbevar denne vejledning sammen med motoren eller med anlægsdokumentationen!</b></p> <p> Dette symbol gør opmærksom på farer og forholdsregler til beskyttelse af personer og genstande:</p> <ul style="list-style-type: none"> <li>• Motorer til AC 230 V må kun tilsluttes af autoriserede personer.</li> <li>• Tilladte spændinger til hjælpekontakter: Se skema under "Apparatdiagrammer".</li> <li>• Motorens tilslutningskabler må ikke ligge i vand.</li> </ul> <p> Apparat i isoleringsklasse II (beskyttelsesisolering)</p> <p> Apparat i isoleringsklasse III (beskyttelsesisolering)</p> <p> <b>OBS!</b> Motoren må ikke åbnes.</p> <p><b>Eltilslutning og idriftsættelse</b> Se den anlægsspecifikke dokumentation samt basisdokumentationen datablad N4604 for motorer.</p>
--	---	---

zh

请将此安装指导文件与驱动器或现场文件保存在一起。

⚠ 此符号代表危险和须要采取措施以对人及财产产生损害:

- 只有被授权的工程人员才可进行 230V 交流电压的电气安装。
- 请参考“图内”有关辅助开关可容许电压表。
- 不要将已连接电缆的驱动器暴露在水中及将电缆安放在水中。

□ 设备安全等级 II (绝缘保护)

⚠ III 设备安全等级 III (绝缘保护)

⚠ 注意! 请不要打开驱动器

**驱动器接线和调试**

请参考调试指导和驱动器技术资料 N4604.

ko

본 지침서는 조작기 또는 관련 설비 자료와 함께 보관 한다.

⚠ 위험요소 와 더불어 인사 및 재산상의 피해를 방지 하기 위한 표시(심볼):

- 전기적 결선(AC230V)은 반드시 전기 공사 면허가 있는 사람에 의해 시행 되어야 한다.
- 보조스위치의 접점용량은 "다이아그램" 상의 테이블에 표시된 내용을 참고한다.
- 조작기의 연결 케이블은 물에 닿지 않도록 주의 한다.

□ 전기안전규격(CE 절연규격) : Class II

⚠ III 전기안전규격(CE 절연규격) : Class III

⚠ 주 의! 조작기를 임의로 열지 마시오.

**결선 및 시운전**

시운전 지침 또는 "데이터 시트" N4604 를 참조

ja

ダンパーアクチュエータを取付ける場合には、この説明書に従って下さい。

⚠ この注意書きを守らないと、傷害を伴う危険と共に、機器を破損する事があります。

- 配線は電気工事士の資格を持った人が行って下さい。
- 補助スイッチの電圧仕様については、接続図の項を参照して下さい。
- アクチュエータへの配線は、水に浸したり、雨にさらされる事のない様施工して下さい。

□ 絶縁保護クラス II

⚠ III 絶縁保護クラス III

⚠ 注意! カバーを外さない事。

**配線及び調整**

製品の仕様書 N4604 を参照して下さい。



**Adapter-Montage**  
Adapter mounting  
Montage de l'adapteur  
Montering av adapter

**Apadper-montage**  
Montaggio dell'adattatore  
Sovittimen asennus  
Montaje del adaptador

**Montering af adapter**  
适配器的安装  
샤프트 어댑터의 조립  
ダンパーシャフトアダプタの取付

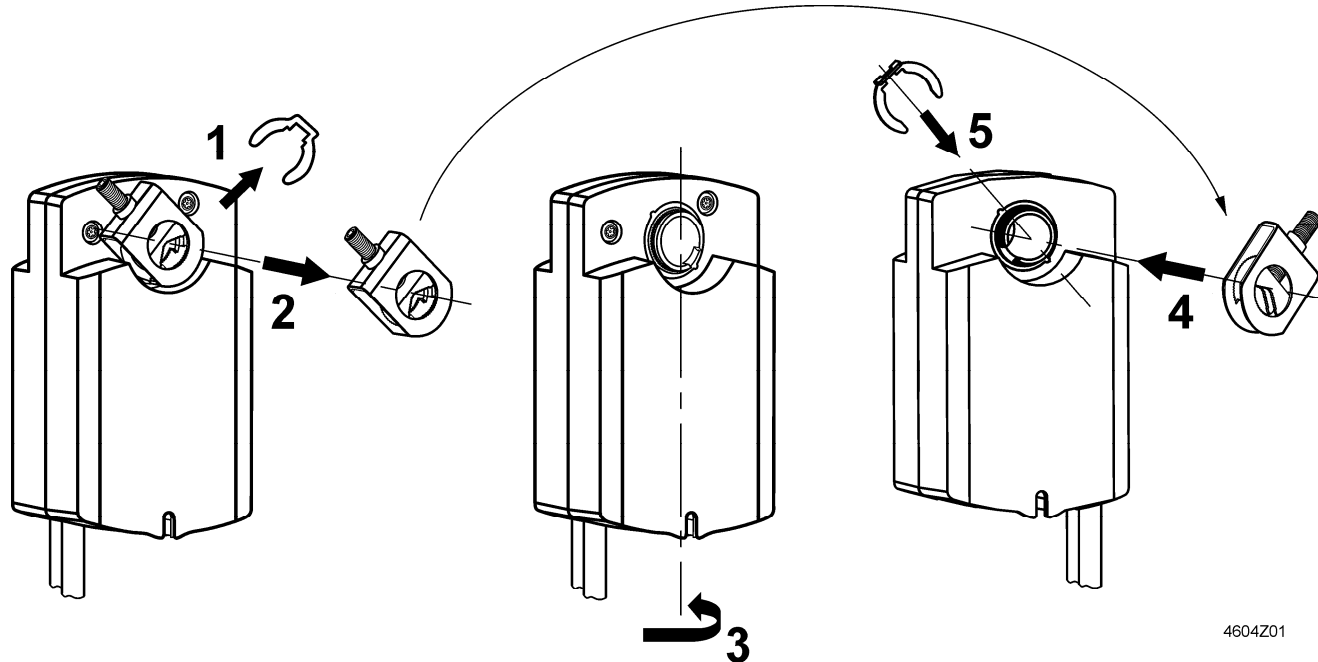

**D**

Montage auf Klappenachse  
 Shaft Mounting  
 Montage sur l'axe des volets  
 Montering på spjællaxel

Montage op de luchtklepas  
 Montaggio sull'asse della serranda  
 Asennus pellin akseliin  
 Montaje sobre el eje de las comp.

Montering på spjældaksel  
 軸的安裝  
 조작기의 설치  
 ダンパーシャフトへの取付

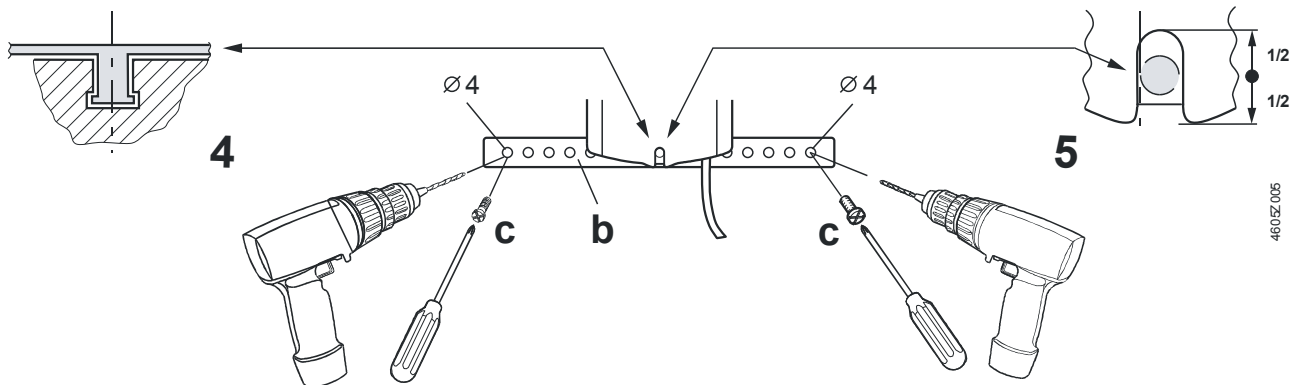
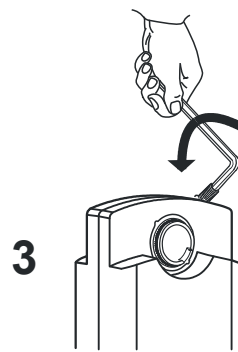
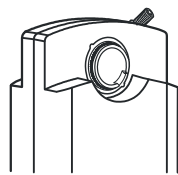
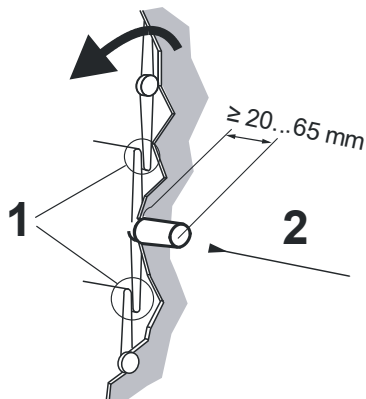
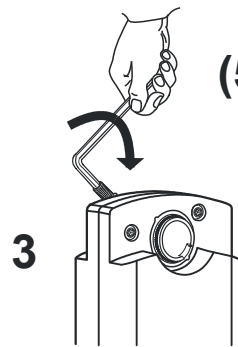
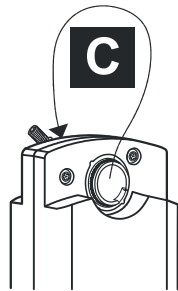
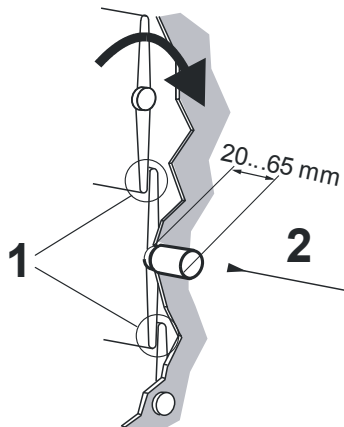
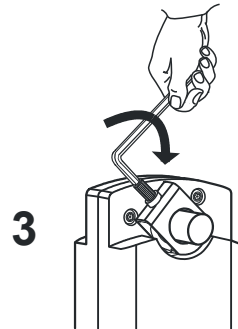
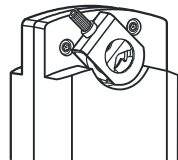
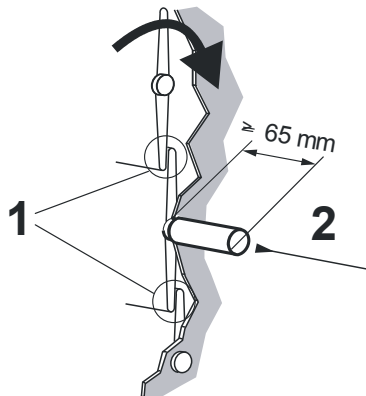

4605Z 005



Massbild  
Dimensions  
Encombremnt  
Måttuppgift

Maatschets  
Ingombri  
Mittapiirros  
Dimensiones

Målskitse  
尺寸  
외형치수  
外形寸法

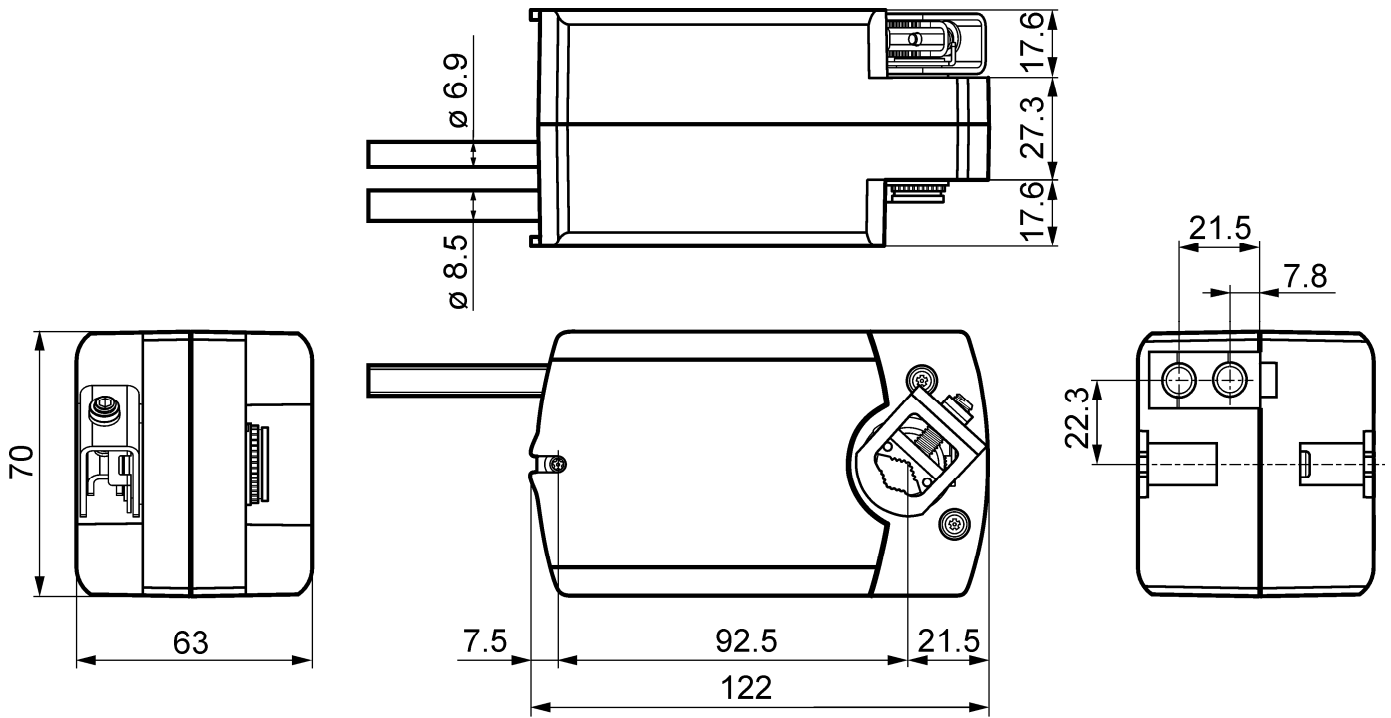

Masse in mm  
Dimensions in mm  
Dimensions en mm

Mått i mm  
Afmetingen in mm  
Dimensioni in mm

Mitat mm  
Dimensiones en mm  
Mål i mm

尺寸单位 mm  
치수 단위 mm  
単位 mm

**Geräteschaltpläne**  
**Wiring diagrams**  
**Schémas de raccordement**  
**Kopplingscheman**

**Aansluitschema's**  
**Schemi di collegamento**  
**KytKentäkaaviot**  
**Conexionado eléctrico**

**Apparatdiagrammer**  
**接线图**  
**결선 회로도**  
**配線接続図**

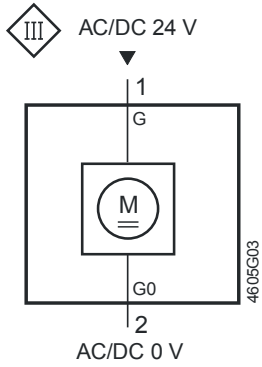

**GQD121.1A**

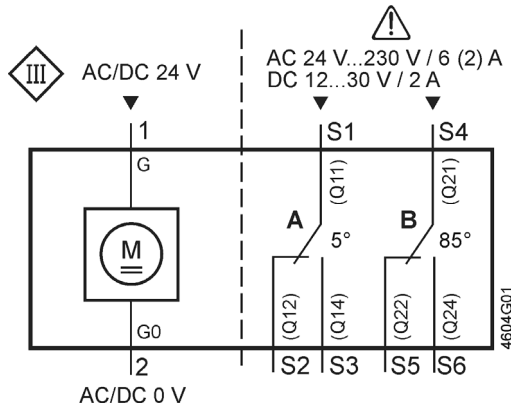

**GQD126.1A**

Zweipunkt-Steuerung  
 Two-position control  
 Commande tout ou rien  
 Tvålåges styrning  
 Tweepuntsbesturing  
 Comando a 2 posizioni  
 Kaksipisteohjaus  
 Control a 2 puntos  
 On/off-styring  
 开关控制  
 2-위치 제어  
 2位置タイプ

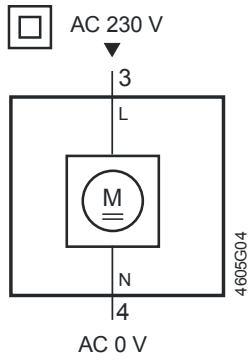

**GQD321.1A**

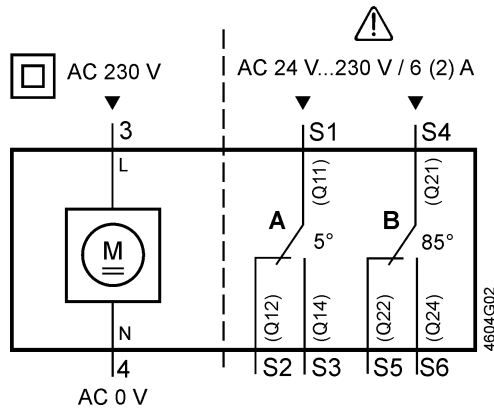

**GQD326.1A**

Zweipunkt-Steuerung  
 Two-position control  
 Commande tout ou rien  
 Tvålåges styrning  
 Tweepuntsbesturing  
 Comando a 2 posizioni  
 Kaksipisteohjaus  
 Control a 2 puntos  
 On/off-styring  
 开关控制  
 2-위치 제어  
 2位置タイプ

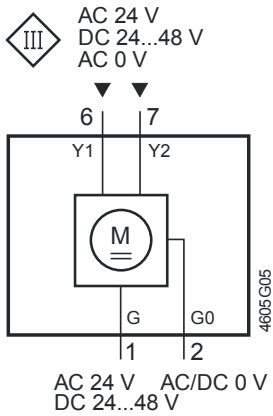

**GQD131.1A**

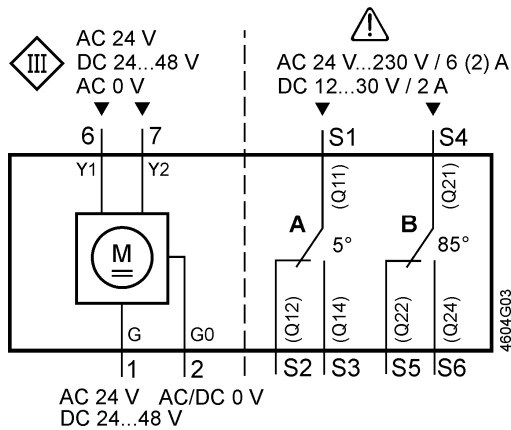

**GQD136.1A**

Dreipunkt-Steuerung  
 Three-position control  
 Commande 3 points  
 Trelåges styrning  
 Driepuntsbesturing  
 Comando a 3 punti  
 Kolmipisteohjaus  
 Control a 3 puntos  
 Trepunktsstyring  
 三位控制  
 3-위치 제어  
 3位置タイプ

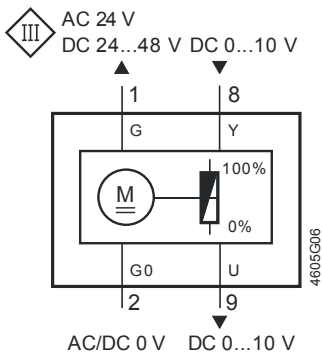

**GQD161.1A**

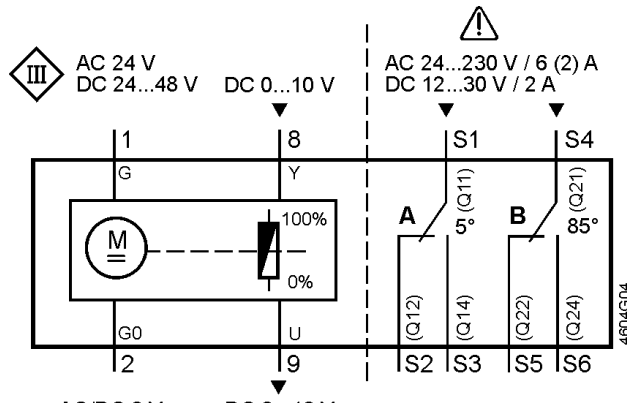

**GQD166.1A**

Stetigsteuerung DC 0...10 V  
 Modulating control DC 0...10 V  
 Commande progressif DC 0...10 V  
 Kontinuerlig styrsignal 0...10 V DC  
 Modulere besturing 0...10 VDC  
 Comando analogico 0...10 V c.c.  
 Moduloiva ohjaus 0...10 V DC  
 Control continuo 0...10 VCC  
 Kontinuerlig styring DC 0...10 V  
 DC 0...10V 连续量控制  
 DC 0...10V 비례제어  
 DC 0...10V 比例タイプ

de

## Kabelbezeichnungen

Anschluss	Kabel				Bedeutung
	Code	Nr.	Farbe	Abkürzung	
Antriebe AC/DC 24 V	G	1	rot	RD	System Potential AC/DC 24 V
	G0	2	schwarz	BK	Systemnull
	Y1	6	violett	VT	Stellsignal AC 24 V / DC 24...48 V oder AC 0 V "Uhrzeigersinn" (GQD13...1A)
	Y2	7	orange	OG	Stellsignal AC 24 V / DC 24...48 V oder AC 0 V "Gegenuhrzeigersinn" (GQD13...1A)
	Y	8	grau	GY	Stellsignal DC 0...10 V (GQD16...1A)
	U	9	rosa	PK	Stellungsanzeige DC 0...10 V (GQD16...1A)
Antriebe AC 230 V	L	3	braun	BN	Phase AC 230 V
	N	4	blau	BU	Nullleiter
Hilfsschalter	Q11	S1	grau/rot	GYRD	Schalter A Eingang
	Q12	S2	grau/blau	GYBU	Schalter A Ruhekontakt
	Q14	S3	grau/rosa	GYPK	Schalter A Schliesskontakt
	Q21	S4	schwarz/rot	BKRD	Schalter B Eingang
	Q22	S5	schwarz/blau	BKBU	Schalter B Ruhekontakt
	Q24	S6	schwarz/rosa	BKPK	Schalter B Schliesskontakt

en

## Wire designations

Connection	Cable				Meaning
	Code	No.	Color	Abbreviation	
AC/DC 24 V Actuators	G	1	red	RD	System potential AC/DC 24 V
	G0	2	black	BK	System neutral
	Y1	6	violet	VT	Positioning signal AC 24 V / DC 24...48 V or AC 0 V "clockwise" (GQD13...1A)
	Y2	7	orange	OG	Positioning signal AC 24 V / DC 24...48 V or AC 0 V "counterclockwise" (GQD13...1A)
	Y	8	grey	GY	Positioning signal DC 0...10 V (GQD16...1A)
	U	9	pink	PK	Position indication DC 0...10 V (GQD16...1A)
AC 230 V Actuators	L	3	brown	BN	Line AC 230 V
	N	4	blue	BU	Neutral
Auxiliary switch	Q11	S1	gray/red	GYRD	Switch A input
	Q12	S2	gray/blue	GYBU	Switch A normally closed contact
	Q14	S3	gray/pink	GYPK	Switch A normally open contact
	Q21	S4	black/red	BKRD	Switch B input
	Q22	S5	black/blue	BKBU	Switch B normally closed contact
	Q24	S6	black/pink	BKPK	Switch B normally open contact

fr

## Désignation des câbles

Câbles de raccordement	Câble				Signification
	Code	No.	Couleurs	Abbréviation	
servo-moteurs AC/DC 24 V	G	1	rouge	RD	Potentiel du système AC/DC 24 V
	G0	2	noir	BK	Zéro du système
	Y1	6	violet	VT	Signal de commande AC 24 V / DC 24...48 V ou AC 0 V "sens horaire" (GQD13...1A)
	Y2	7	orange	OG	Signal de commande AC 24 V / DC 24...48 V ou AC 0 V "sens anti-horaire" (GQD13...1A)
	Y	8	gris	GY	Signal de commande DC 0...10 V (GQD16...1A)
	U	9	rose	PK	Signal de position DC 0...10 V (GQD16...1A)
servo-moteurs	L	3	brun	BN	Phase AC 230 V
	N	4	bleu	BU	Neutre
commutateurs auxiliaires	Q11	S1	gris/rouge	GYRD	commutateur A entrée
	Q12	S2	gris/bleu	GYBU	commutateur A contact de repos
	Q14	S3	gris/rose	GYPK	commutateur A contact de travail
	Q21	S4	noir/rouge	BKRD	commutateur B entrée
	Q22	S5	noir/bleu	BKBU	commutateur B contact de repos
	Q24	S6	noir/rose	BKPK	commutateur B contact de travail

电缆说明	连接	线缆				注解
		端子号	端子	颜色	缩写	
AC/DC 24 V 驱动器	G	1	红色	RD	供电类型为 AC/DC 24 V 中性线 驱动器控制信号 AC 24 V / DC 24...48 V, AC 0 V "顺时针旋转" (GQD13...1A) 驱动器控制信号 AC 24 V / DC 24...48 V, AC 0 V "逆时针旋转" (GQD13...1A) 连续量调节信号 DC 0...10 V (GQD16...1A) 位置反馈信号 DC 0...10 V (GQD16...1A)	
	G0	2	黑色	BK		
	Y1	6	紫色	VT		
	Y2	7	橙色	OG		
	Y	8	灰色	GY		
	U	9	粉色	PK		
AC 230 V 驱动器	L	3	啡色	BN	相线 AC 230 V	
	N	4	蓝色	BU		中性
辅助开关	Q11	S1	灰/红	GYRD	辅助开关 A 输入公共端子 辅助开关 A 常闭端子 辅助开关 A 常开端子 辅助开关 B 输入公共端子 辅助开关 B 常闭端子 辅助开关 B 常开端子	
	Q12	S2	灰/蓝	GYBU		
	Q14	S3	灰/蓝	GYPK		
	Q21	S4	黑/红	BKRD		
	Q22	S5	黑/蓝	BKBU		
	Q24	S6	黑/粉	BKPK		

결선 케이블	구분	케이블				내용
		코드	번호	색상	약어(약자)	
AC/DC 24 V 조작기	G	1	적색	RD	공급전원 AC/DC 24 V 시스템 뉴트럴 동작신호 AC 24 V / DC 24...48 V, AC 0 V "시계방향 회전" (GQD13...1A) 동작신호 AC 24 V / DC 24...48 V, AC 0 V "반시계방향 회전" (GQD13...1A) 동작신호 DC 0...10 V (GQD16...1A) 위치 지시 신호 DC 0...10 V (GQD16...1A)	
	G0	2	흑색	BK		
	Y1	6	자주색	VT		
	Y2	7	오렌지색	OG		
	Y	8	회색	GY		
	U	9	분홍색	PK		
AC 230 V 조작기	L	3	갈색	BN	동작 신호 AC 230 V 뉴트럴 (N)	
	N	4	청색	BU		
보조 스위치	Q11	S1	회색/적색	GYRD	스위치 A 입력 스위치 A (노멀 클로즈 접점) 스위치 A (노멀 오픈 접점) 스위치 B 입력 스위치 B (노멀 클로즈 접점) 스위치 B (노멀 오픈 접점)	
	Q12	S2	회색/청색	GYBU		
	Q14	S3	회색/분홍색	GYPK		
	Q21	S4	흑색/적색	BKRD		
	Q22	S5	흑색/청색	BKBU		
	Q24	S6	흑색/분홍색	BKPK		

付属ケーブルの内容	内容	ケーブル				仕様
		コード	No.	色	記号	
電源 AC/DC 24 V	G	1	赤	RD	システムポテンシャル AC/DC 24 V システムニュートラル 操作信号 AC 24 V / DC 24...48 V, AC 0V "時計廻り" (GQD13...1A) 操作信号 AC 24 V / DC 24...48 V, AC 0V "反時計廻り" (GQD13...1A) 操作信号 DC 0...10 V (GQD16...1A) 開度信号 DC 0...10 V (GQD16...1A)	
	G0	2	黒	BK		
	Y1	6	紫	VT		
	Y2	7	オレンジ	OG		
	Y	8	灰	GY		
	U	9	ピンク	PK		
電源 AC 230 V	L	3	茶	BN	相電圧 AC 230 V ニュートラル	
	N	4	青	BU		
補助スイッチ	Q11	S1	灰/赤	GYRD	スイッチ A コモン スイッチ A "常時閉" 信号 スイッチ A "常時閉" 信号 スイッチ B コモン スイッチ B "常時閉" 信号 スイッチ B "常時閉" 信号	
	Q12	S2	灰/青	GYBU		
	Q14	S3	灰/ピンク	GYPK		
	Q21	S4	黒/赤	BKRD		
	Q22	S5	黒/青	BKBU		
	Q24	S6	黒/ピンク	BKPK		